

Dettagli colonna verticale
Mast section details

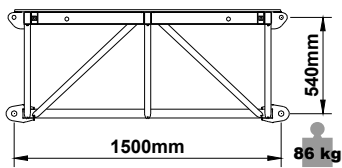

Dettagli modulo ponte
Deck module details

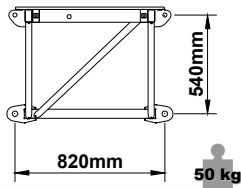

Dettagli modulo ponte
Deck module details

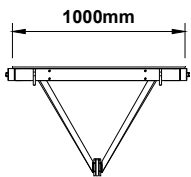

Vista frontale modulo ponte
Deck Module Front View

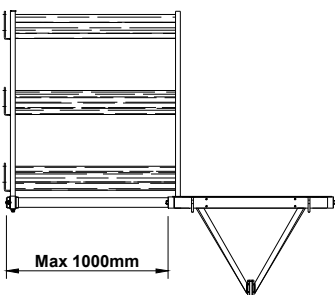

Estensioni a parete
Telescopic Wall Extensions

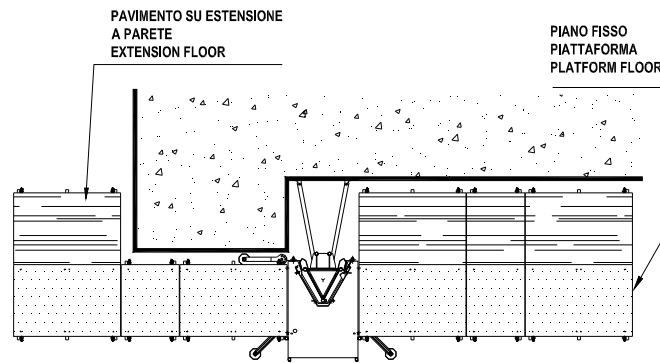
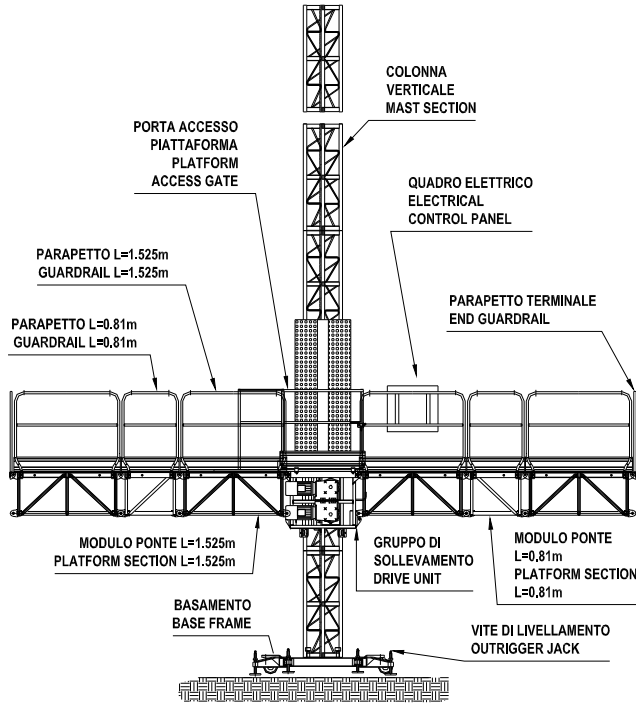

PAVIMENTO SU ESTENSIONE A PARETE
EXTENSION FLOOR

PIANO FISSO PIATTAFORMA
PLATFORM FLOOR

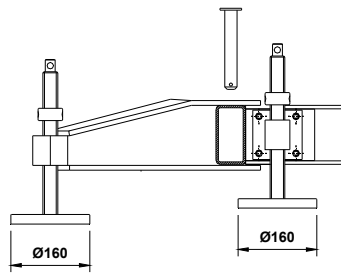

Stabilizzatori rimovibili
Removable outriggers

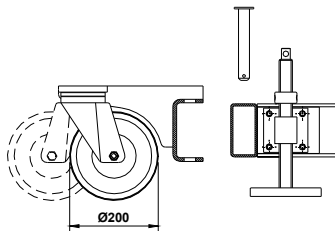

Ruote pivotanti rimovibili
Removable pivoting wheels

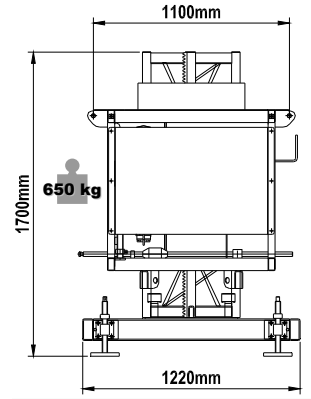

Dettagli gruppo di sollevamento
Drive unit details

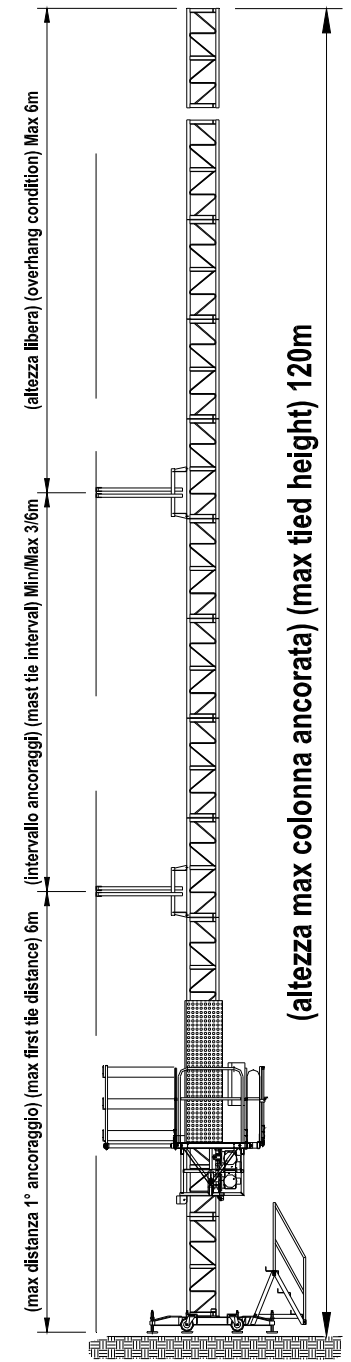

Dettagli ancoraggi
Tie details