

PIATTAFORMA DI LAVORO AUTOSOLLEVANTE SU COLONNA - MONOCOLONNA
PLATAFORMA DE TRABAJO SOBRE MASTIL - MONOMASTIL

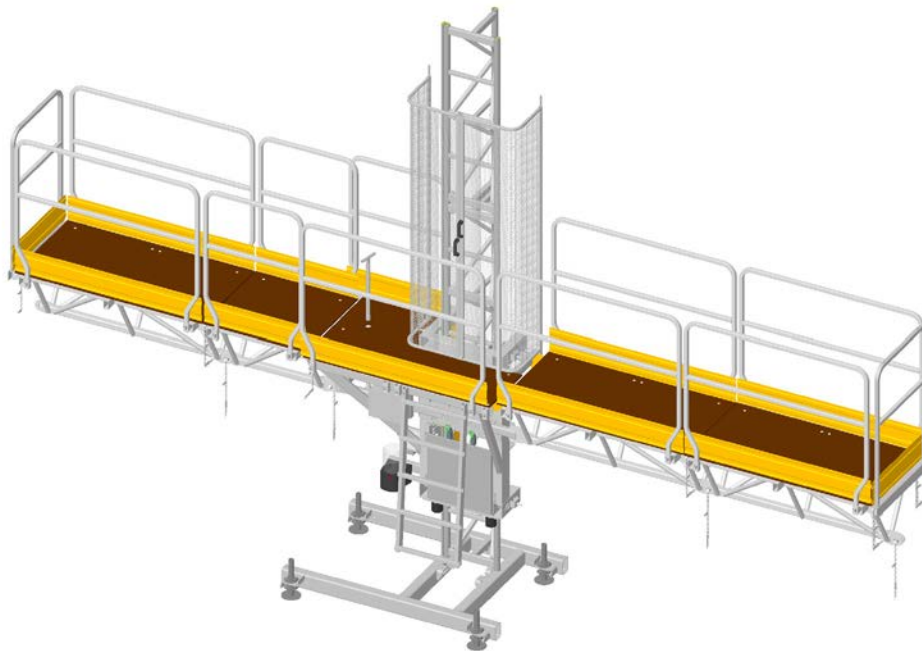

PIATTAFORMA DI LAVORO AUTOSOLLEVANTE SU COLONNA - BICOLONNA
PLATAFORMA DE TRABAJO SOBRE MASTIL - BIMASTIL

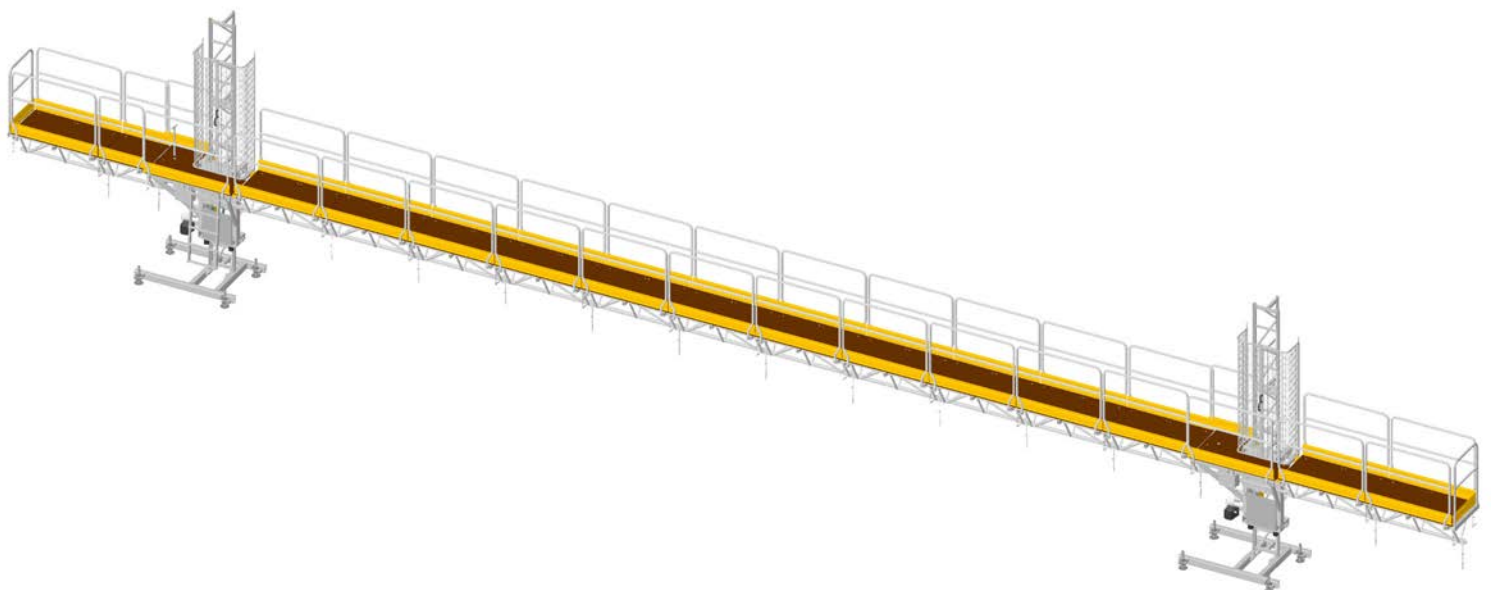



Dati tecnici	Technical Data	Datos Tecnicos	ELSA P26 /7 Monofase	ELSA P26 /21 Monofase	ELSA P26 /7	ELSA P26 /25
Massima capacità di carico	Max. capacity	Max capacidad de carga	1240 kg	2400 kg	1650 kg	3400 kg
Velocità di sollevamento	Lifting speed	Velocidad de elevación	da 5 a 8 m/min	da 5 a 8 m/min	10,6 m/min	10,6 m/min
Max lunghezza piattaforma	Max platform length	Longitud Max Plataforma	7,0 m	21,86 m	7,0 m	24,86 m
Larghezza piattaforma	Platform width	Ancho Plataforma	0,8 m	0,8 m	0,8 m	0,8 m
Lunghezza Standard estensioni telesc.	Standard telesc. extension	Longitud standard extensiones	0,8 m	0,8 m	0,8 m	0,8 m
Max. Lunghezza estensioni telesc.	Max extension length	Longitud Max extensiones	2 m * max	2 m* max	2 m* max	2 m* max
Massima altezza libera	Max freestanding height	Altura Max autoestable	6 m	6 m	6 m	6 m
Massima altezza ancorata	Max anchored height	Altura Max anclajes	160 m	160 m	160 m	160 m
Intervallo ancoraggi	Max tie distance	Distancia entre anclajes	7,5 m max	7,5 m max	7,5 m max	7,5 m max
Tensione alimentazione	Input power range	Tension de red	200 230 V - 50-60 Hz	200 230 V - 50-60 Hz	230-400V-50 Hz 275/480 V- 60Hz	230-400V-50Hz 275/480V-60Hz
Potenza servizio continuo	Power of the motors	Potencia de motorreductores	1 x 1,1 Kw	2 x 1,1 Kw	1x 3 kW	2 x 3 kW
Minima potenza di linea consigliata	Minimum line power suggested	Min. potencia de linea	3 Kw	3 Kw	6 kW	10 kW
Dispositivo paracadute	Parachute safety device	Dispositivo de seguridad paracaídas	✓	✓	✓	✓
Ingrassatore automatico cremagliera	Rack automatic greasing pump	Engrasador automatico de cremallera	✓	✓	✓	✓
Sistema di sovraccarico	Overload system	Limitador de carga	✓	✓	✓	✓

* Contattare Electroelsa

* Contact Electroelsa

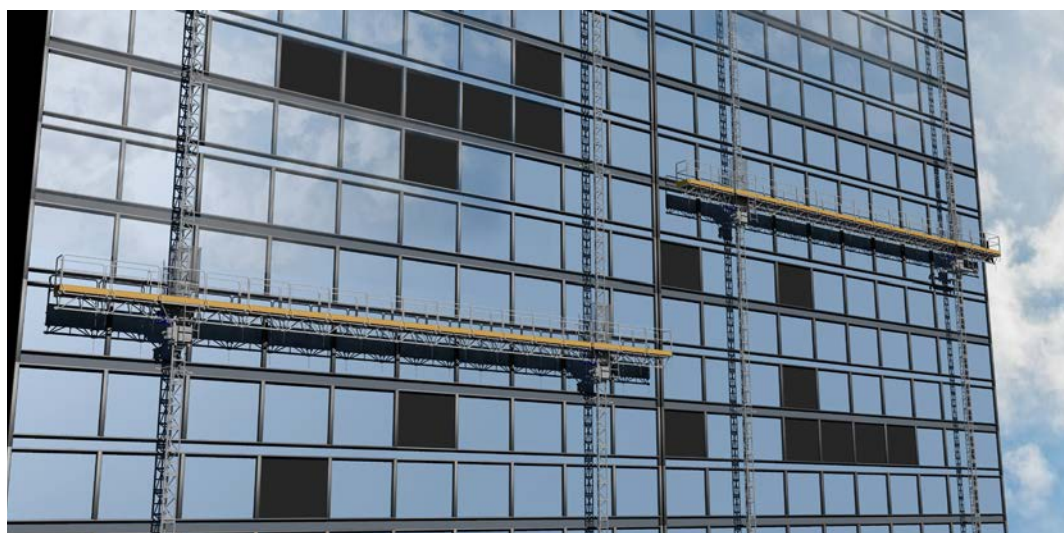

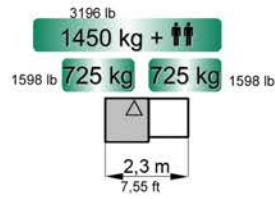

2 people = 240 kg
3 people = 400 kg

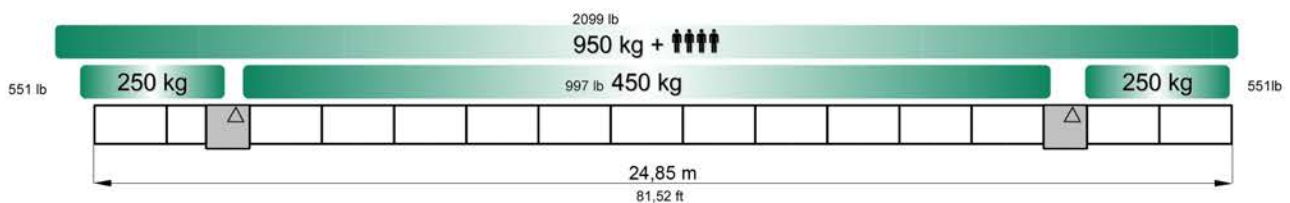
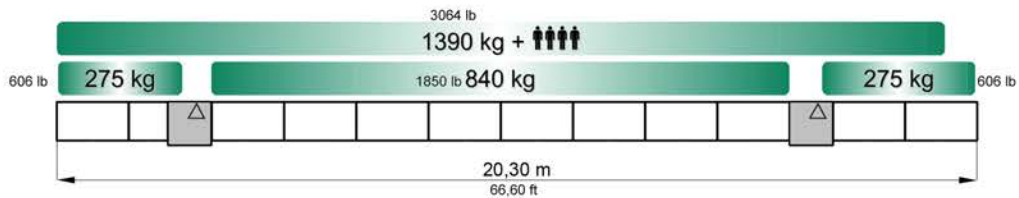
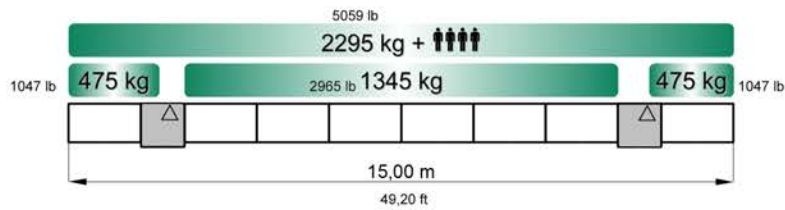
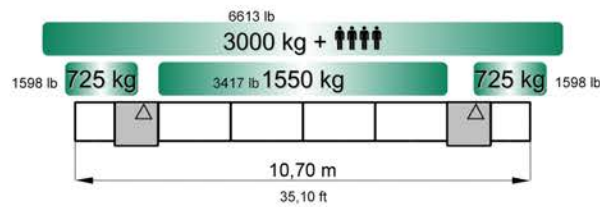
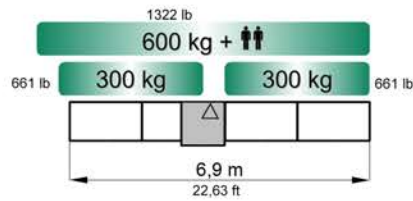
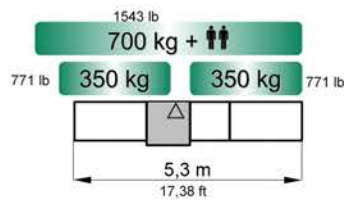
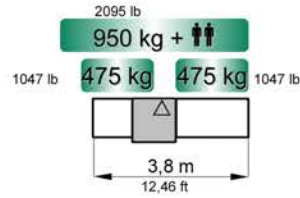

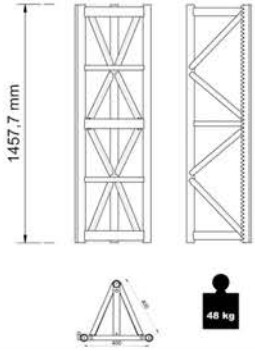

Dettagli colonna verticale
Mast section details

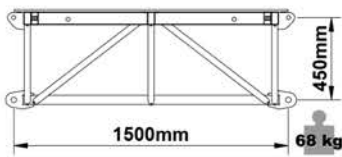

Dettagli modulo ponte
Deck module details

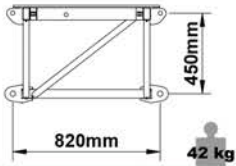

Dettagli modulo ponte
Deck module details

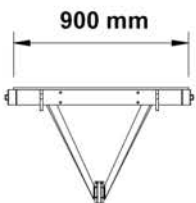

Vista frontale modulo ponte
Deck Module Front View

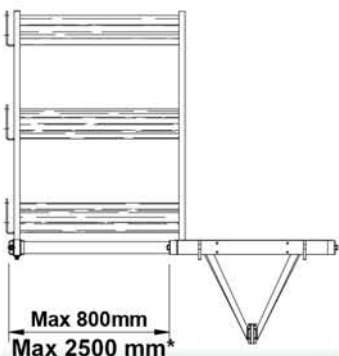

Estensioni a parete
Telescopic Wall Extensions

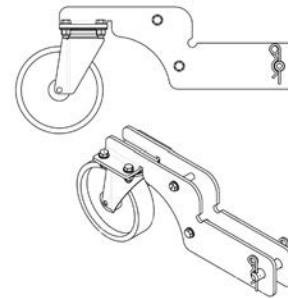
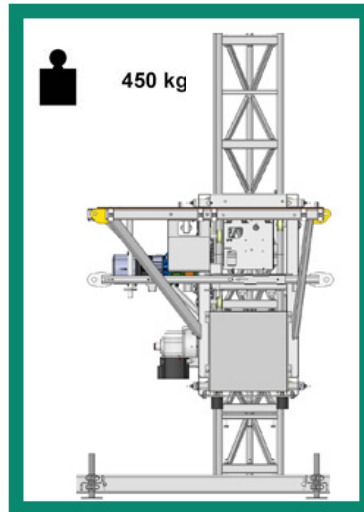
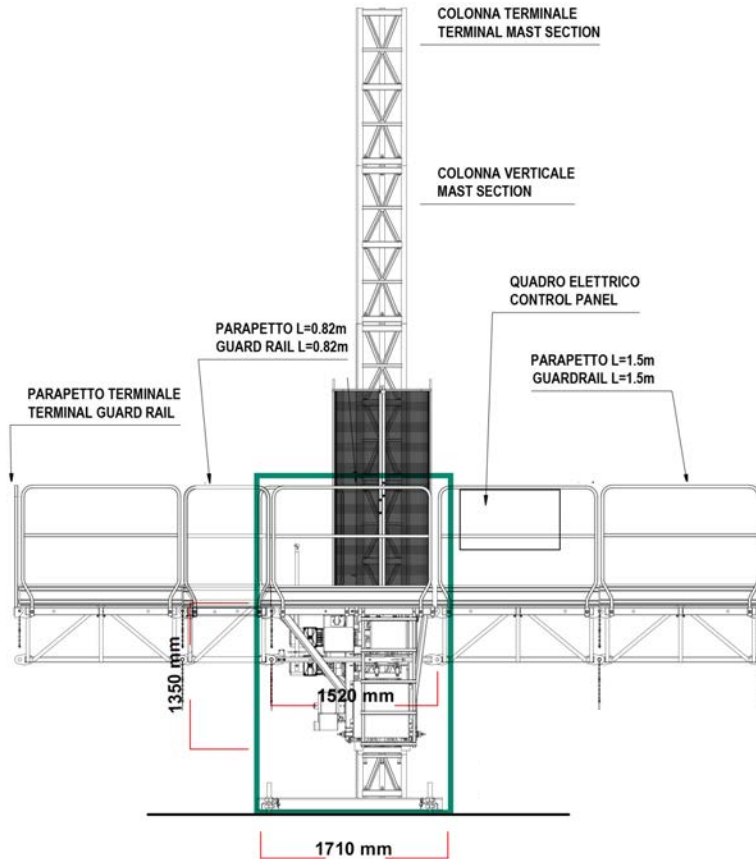

Ruote pivotanti rimovibili
Removable pivoting wheels

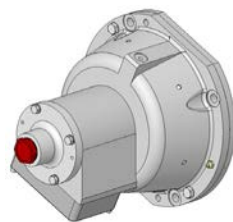

Freno d'emergenza ad arresto progressivo
Overspeed safety device with progressive stop

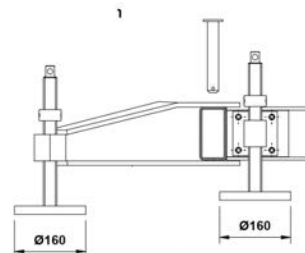

Stabilizzatori rimovibili
Removable outriggers

ALTEZZA LIBERA MAX 6 m
OVERHANG CONDITION MAX 6 m

INTERVALLO ANCORAGGIO 3/6 m
MAST TIE INTERVAL MIN/MAX 3/6 m

MAX DISTANZA PRIMO ANCORAGGIO 6m
MAX FIRST TIE DISTANCE 6 m